



Set-Top Box & Remote

KSTB2020

KAONMEDIA



| User Installation Guide |

Rev.021721

TABLE OF CONTENTS

WHAT'S IN THE BOX?	3
SET-TOP BOX AT A GLANCE	4
BUTTON FUNCTIONALITY	6
SELF-INSTALL PHYSICAL PLACEMENT GUIDELINES	7
SELF-INSTALL CONNECTION GUIDELINES	8
INITIAL BOX POWER ON	12
NETWORK SETUP	18
SERVICE VALIDATION	19
TROUBLESHOOTING	20
APPENDIX A : TV Codes for Remote Pairing	21
APPENDIX B : Audio System Codes for Remote Pairing	33



Manufactured under license from Dolby Laboratories. Dolby, Dolby Audio, and the double-D symbol are trademarks of Dolby Laboratories.



The Adopted Trademarks HDMI, HDMI High-Definition Multimedia Interface, and the HDMI Logo are trademarks or registered trademarks of HDMI Licensing Administrator, Inc. in the United States and other countries.

WHAT'S IN THE BOX?



KSTB2020
Set-Top Box (STB)



HDMI Cable



Power Adapter



Kaon Voice
Classic RCU



AA Batteries



RCA Analog Composite
Breakout Cable
(Optional)

SET-TOP BOX AT A GLANCE

Top View

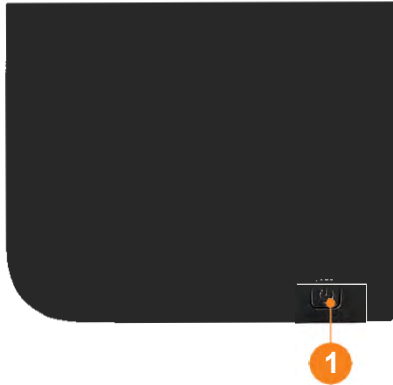

1 Power Button

Used to power the Kaon STB On or Off.

Front View



2 Status Indicator LED

Indicates power status of STB (Red = Off, Green = On).

3 Infrared (IR) Sensor

Used to communicate with the KURV Remote Control.

Rear View



4 RJ45

10/100 Ethernet port used to connect to a home router.

5 HDMI

Digital A/V output, used to connect to a TV via HDMI cable.

6 AV Out

SD Analog A/V output, used to connect to older-style TVs that do not support HDMI connections. Ask your installer for an RCA composite breakout cable if one was not included.

7 S/PDIF

Optical Audio output, used to connect to external Sound bar or Surround Sound system. An optical cable with TOSLINK connectors is required (not included).

8 12V/1.5A In

DC Power port, used to connect via the power adapter.

Side View



9 USB

This port has an output power capability of 5V DC @ 1 amp.

BUTTON FUNCTIONALITY



- 1 TV ON
- 2 TV/STB ON
- 3 Fast Backward
- 4 Play/Pause
- 5 Fast Forward
- 6 TV Guide
- 7 Live TV
- 8 OK
- 9 Up/Down/Left/Right
- 10 Return
- 11 Home
- 12 Voice Assistance
- 13 Volume Up
- 14 Mute
- 15 Volume Down
- 16 CH UP
- 17 Last Channel Watched
- 18 CH Down
- 19 Menu
- 20 Device Input
- 21 Remote Set
- 22 Number Pad

SELF-INSTALL PHYSICAL PLACEMENT GUIDELINES

The KSTB2020 set-top box should be placed in a location away from direct or indirect heat sources.



Remote Operating in IR Mode

With the remote operating in IR mode, it is recommended that the KSTB2020 be placed in sight for the end user. The IR sensor is in center of the front face plate.

Remote Operating in RF4CE Mode

With the remote operating in RF mode, the KSTB2020 may be placed out of sight. This may include behind a wall-mounted TV or in a TV cabinet.

USAGE CONSTRAINTS

External DVR via USB Drive

The USB port cannot be used to connect an external USB drive to support local DVR capability.

SELF-INSTALL CONNECTION GUIDELINES

HDMI Cable Connection

The USB port cannot be used to connect an external USB drive to support local DVR capability.

What You Need

- An HD or Ultra High Definition (UHD) TV that can support 720p, 1080p or 4K UHD.
- A Broadband Internet connection that supports a wired or WiFi wireless home network (802.11 g, n, or ac).
- Pay TV Operator login credentials (mandatory).
- Google login credentials (optional).

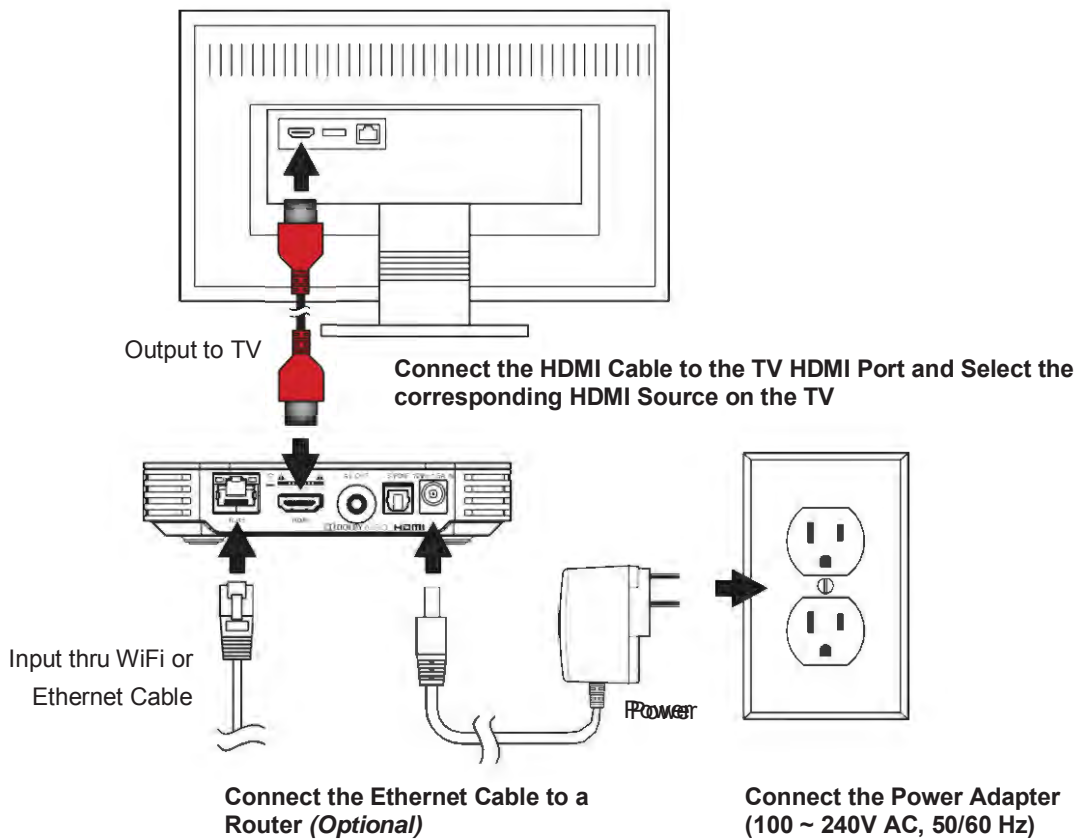

Analog Composite Breakout Cable Connection

Connect the analog composite cable as shown below. This connection scheme should only be used if the TV does not have a working HDMI port.

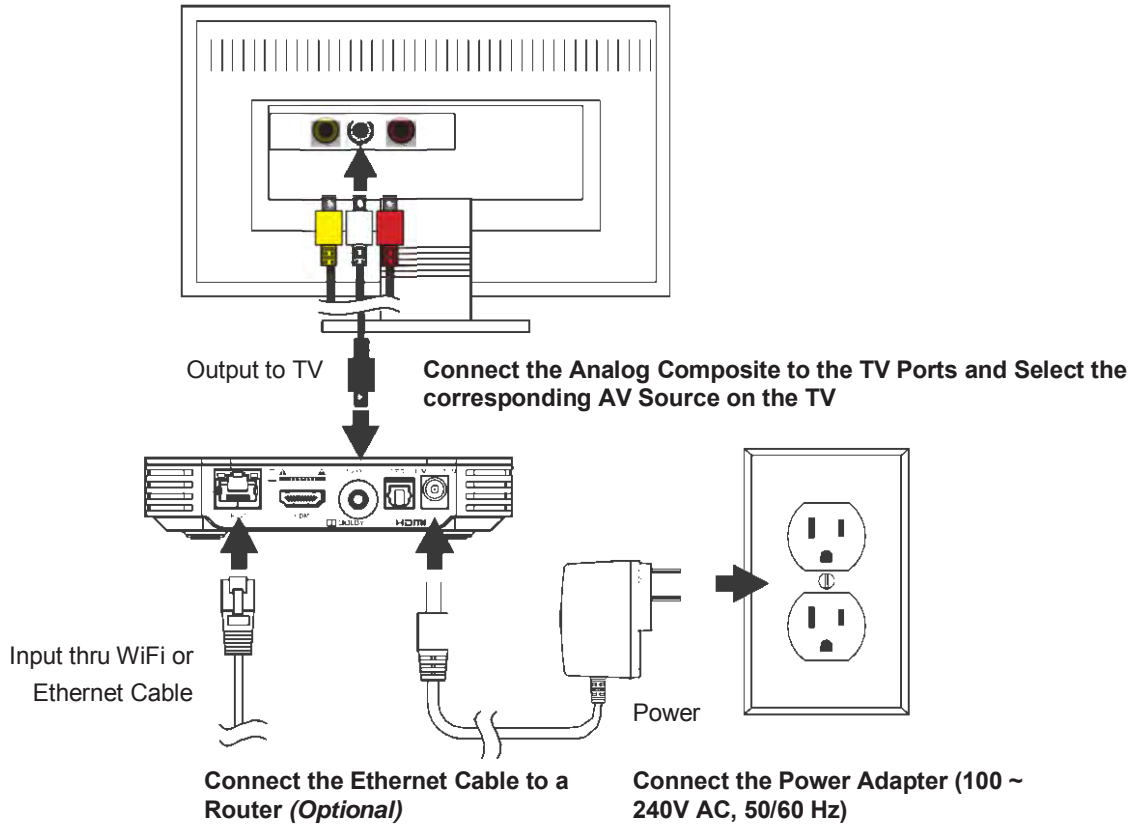

Network Connection

You must connect your new STB to an internet connection through either a WiFi wireless connection or a wired Ethernet connection.

Wired Network Connection

If your home router is near the STB location, a CAT-5/5e/6 Ethernet cable may be used for internet connectivity. Plug one end of the CAT-5/5e/6 cable into the STB RJ45 port. Plug the other end of the cable into any LAN port of your home router.

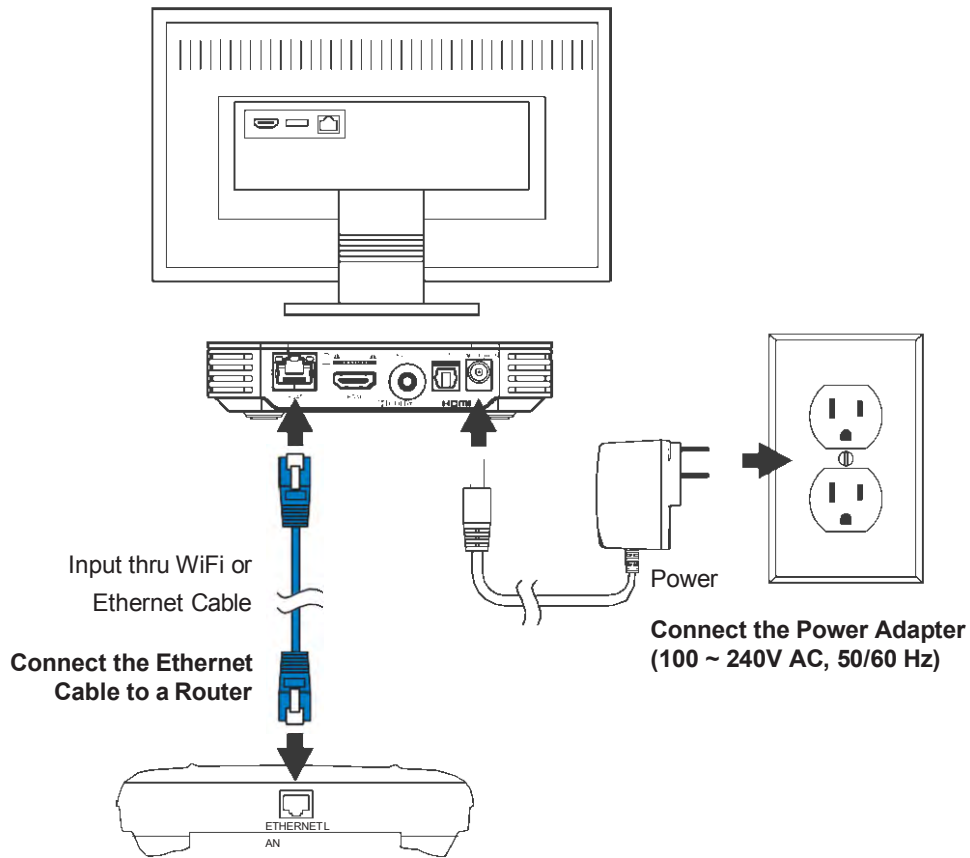

WiFi Network Connection

Connect Automatically Using WPS

Navigate to the Android main menu by pressing the following key sequences:

 Home →  Settings →  Network →  WiFi → Select to enable.

Once WiFi has been enabled, using the remote scroll down and select “Connect via WPS”.

Once selected press the WPS button on your home router. The Set-Top Box will automatically connect to the WiFi network.

Ensure that WiFi network signal strength is strong  or very strong .

Connect Manually

If your home WiFi router does not have a WPS button, you can connect manually. Navigate to the Android main menu by pressing the following key sequences:

 Home →  Settings →  Network →  WiFi → Select to enable.

Once WiFi has been enabled, using the remote scroll down and select the required network and press OK. When prompted, enter your WiFi password using the remote. Alternately a USB keyboard may be plugged into the USB port of the Set-Top Box. Type password on keyboard as required.

Ensure that WiFi network signal strength is strong  or very strong .

INITIAL BOX POWER ON

The following screens describe the remote key sequences required to setup the KSTB2020. When powered up and fully booted, the box will start on this screen.

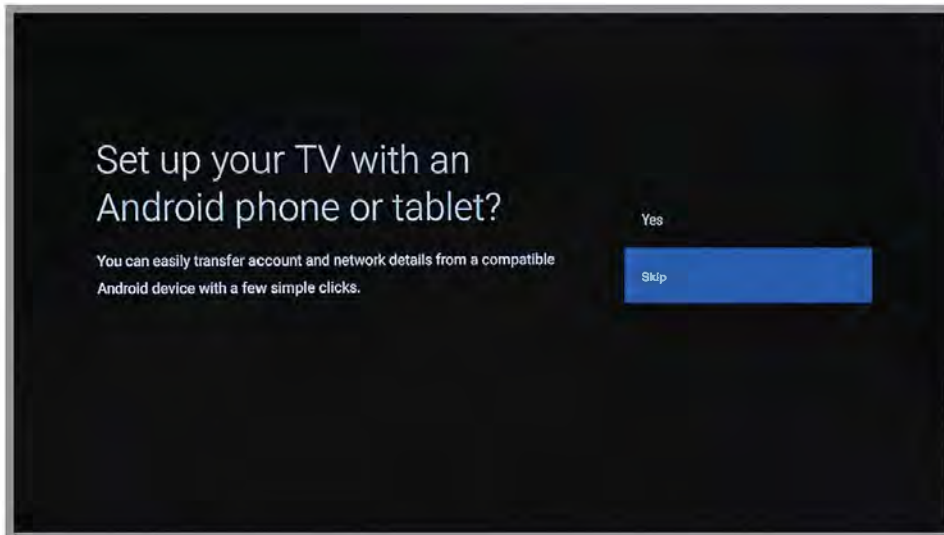

Select **Skip** and press **OK** to continue. The following screen will be displayed.

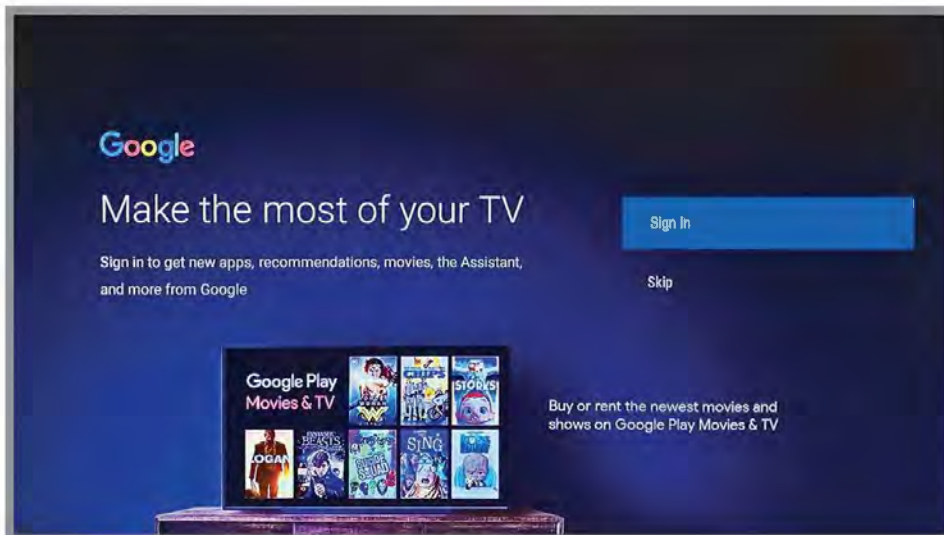

If the end user wishes to login with their Google ID they may do so at this point. If not, select **Skip** and press **OK** to continue.

Once logged in, the following Terms of Service screen will be displayed.
Select Accept and press OK to continue.

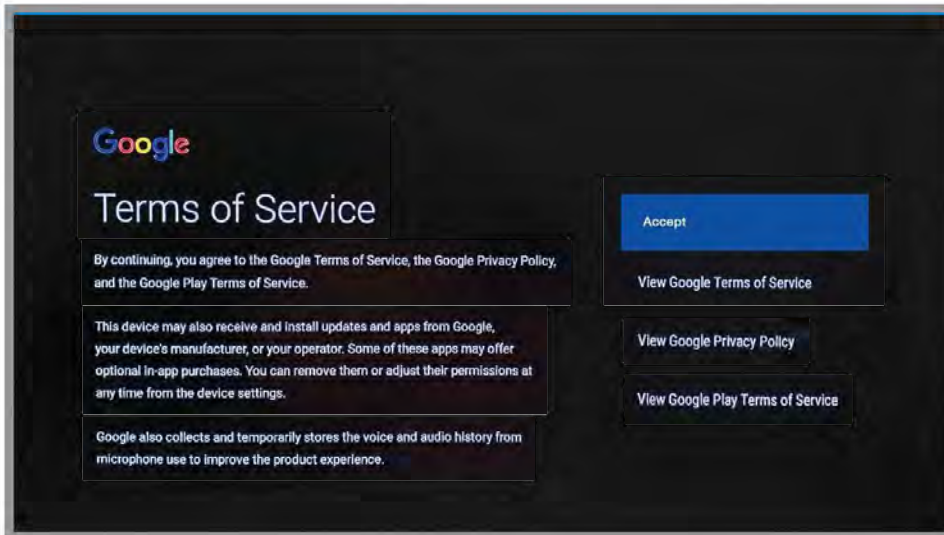

Select Yes on the Location screen and press OK to continue.

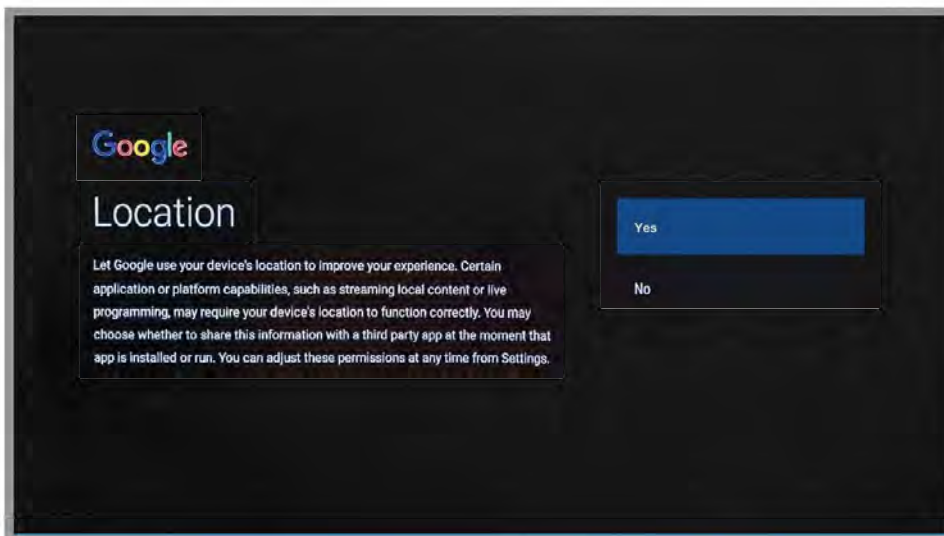

On the Help Improve screen, select **Yes** and press **OK** to continue.

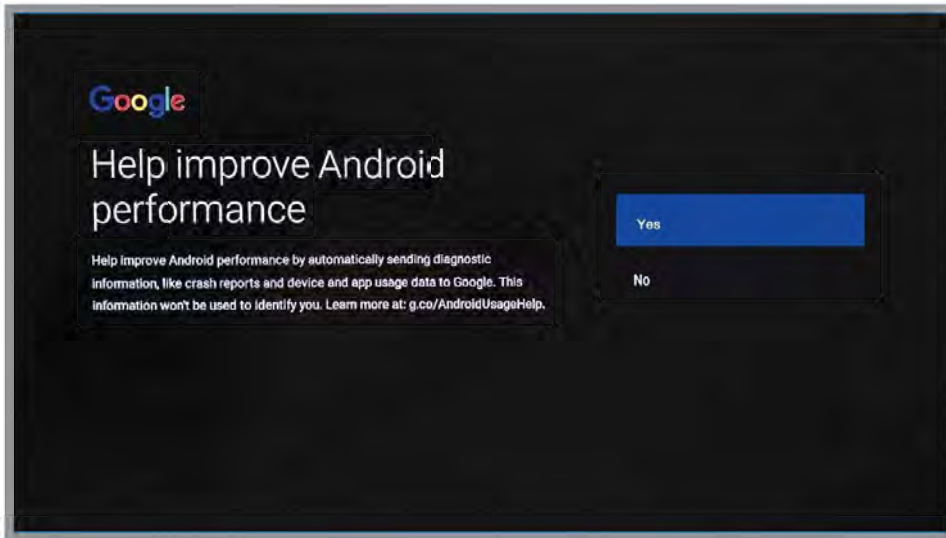

On the Choose a Name screen, select the appropriate name for the unit and press **OK** to continue.

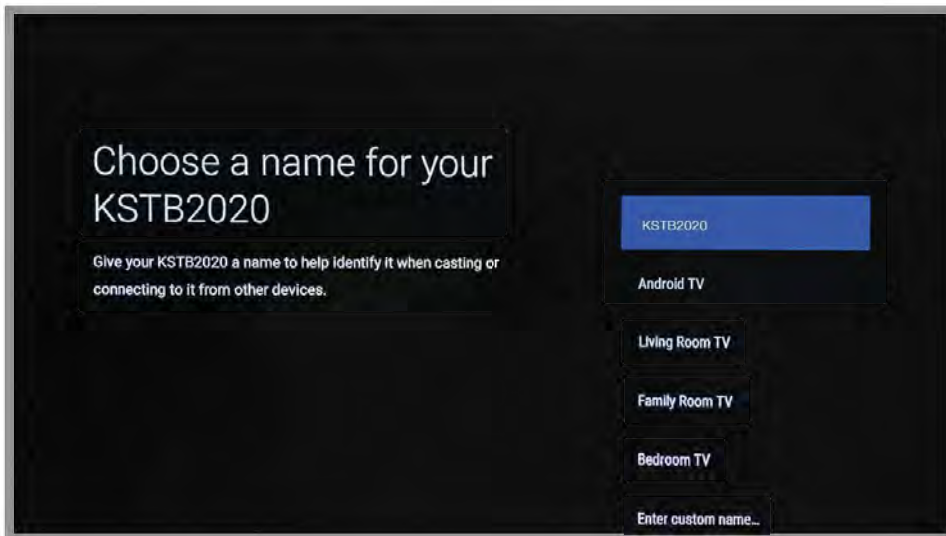

The following Get Started screen will display the login where your Cable Provider App will be located. This app cannot be unselected. Select **Continue** and press **OK** to get to the next screen.



On the Welcome screen, arrow right five times to get to the next screen.



Select **Done** and press **OK** to continue.



When it is finished processing, the Login screen will be displayed.

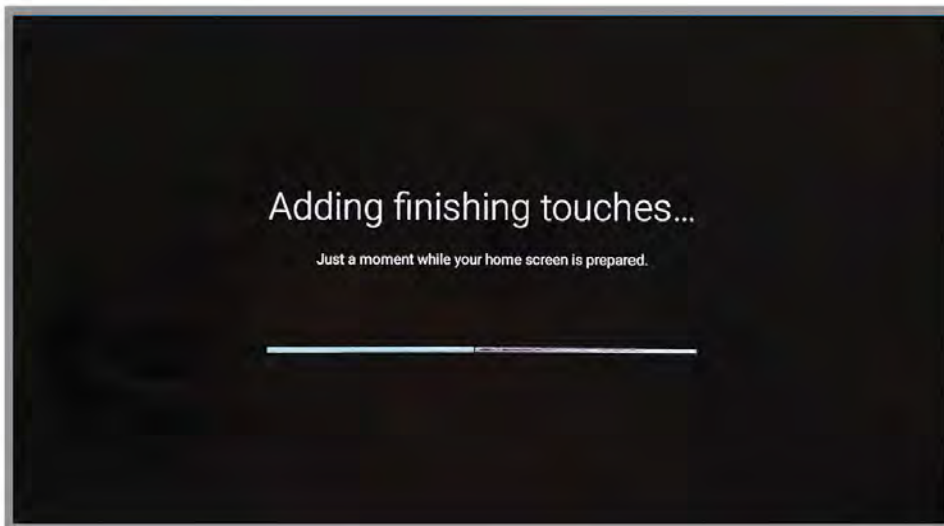

This is where you enter your username

- Put NIT in front of your number
 - NIT has to be capitalized
 - You capitalize the letters by pushing the arrow pointing up on the left-hand side of the keyboard
- Once you have entered your username, you will need to hit the arrow pointing to the right in the bottom right-hand corner (Example A)



Example A



Example B

Now you will need to enter your password (Example B)

- Once your password is entered, you will need to hit the checkmark on the bottom right-hand side of the keyboard
- Your password is your account number without the leading 0s or the dash. You will see this on your bill.

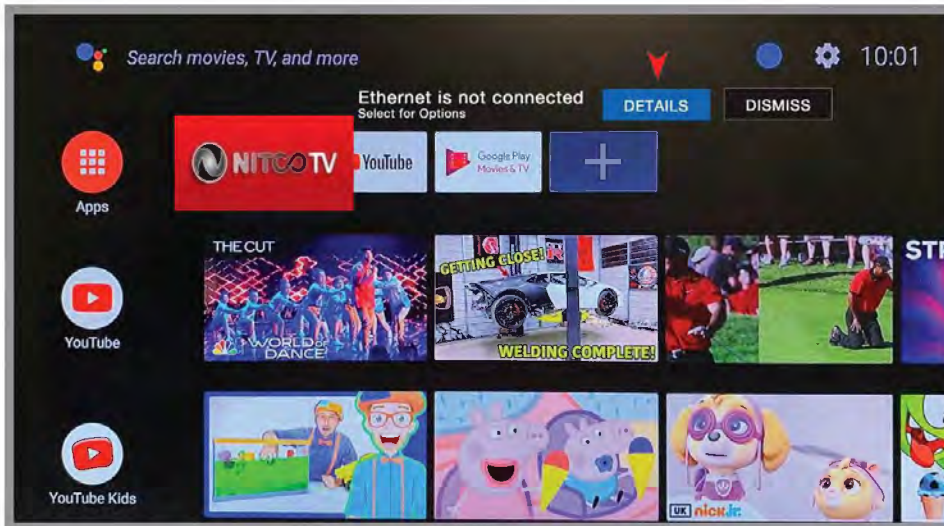

Once logged in, the following screen will be displayed. Select "DETAILS" to be prompted for Wi-Fi network section and sign in. Alternately an Ethernet cable may be connected at this time.

NETWORK SETUP



Wi-Fi Requirements

Navigate to the Android main menu by pressing the following key sequences:

 Home →  Settings →  Network →  WiFi → Select to enable.

Once WiFi has been enabled, using the remote scroll down and select “Connect via WPS”.

Once selected press the WPS button on your home router. The Set-Top Box will automatically connect to the WiFi network.



Ensure that WiFi network signal strength is strong  or very strong .

Connect Manually

If your home WiFi router does not have a WPS button, you can connect manually. Navigate to the Android main menu by pressing the following key sequences:

 Home →  Settings →  Network →  WiFi → Select to enable.

Once WiFi has been enabled, using the remote scroll down and select the required network and press OK. When prompted, enter your WiFi password using the remote. Alternately a USB keyboard may be plugged into the USB port of the Set-Top Box. Type password on keyboard as required.

Ensure that WiFi network signal strength is strong  or very strong .

SERVICE VALIDATION

RCU/STB Operation

Once STB has been installed and credentials have been entered, the user should confirm that remote works as expected with STB. The user should check the following buttons for correct operation.

- Volume up/down
- Channel up/down
- Menu
- Home
- Guide
- Shows
- Movies





General Video Quality

User should validate that overall video quality is as expected. If possible, tune to a channel with fast moving scenes (e.g. football or hockey game).

Signal Strength Validation



Signal strength may be checked via the network sub-menu in the Android main menu.

Using the remote and android menu navigate to the following:

 Home →  Settings →  Network → 

Ensure that WiFi network signal strength is strong  or very strong .

TROUBLESHOOTING

Observation	Things to Check	Remediation
Video/audio quality is poor on STB or network connection error is displayed.	<p>WiFi signal strength in STB Network connection menu.</p> <p>Ideal for consistent video:</p> <p>Strong WiFi signal Very Strong WiFi signal</p> <p>Video may buffer frequently or will not be consistent:</p> <p> Weak WiFi signal  Medium WiFi signal</p>	<p>Relocate router and STB closer in proximity with each other if possible, such that signal is strong or very strong.</p> <p>Connecting the STB to home router with a CAT-5/5e/ cable will also resolve poor WiFi connectivity issues.</p> <p>If video or audio quality is still poor after correcting network, contact your cable provider technical support.</p>
	<p>Ethernet cable integrity</p> <p></p>	<p>If wired Ethernet connectivity is used, reset/replace Ethernet cable as required.</p>
	<p>Router integrity</p>	<p>Power cycle STB and router.</p>
	<p>HDMI/Analog composite cable integrity and connection.</p>	<p>Reset/replace cables as needed.</p>
	<p>TV HDMI port integrity.</p>	<p>Use different TV HDMI port if possible.</p>
	<p>If possible, compare suspect STB A/V quality to another device such as a Blu-ray player.</p>	<p>If the STB is found to show issues while no other devices do, contact your cable provider technical support.</p>
Video is not visible on the TV.	<p>HDMI port connection is aligned with the TV's HDMI port selection.</p>	<p>Ensure HDMI port connection and HDMI port selection are the same.</p>
Remote does not control STB, TV, or audio equipment.	<p>Battery charge</p>	<p>Replace batteries if charge is low.</p>
	<p>Remote is not programmed to TV or Audio system.</p>	<p>Refer to pages 8 or 12 for KURV remote pairing instructions.</p>
	<p>A Remote Control button press always lights up the LED at the top of the remote. Red = an IR command sent. Green = an RF command sent.</p>	<p>If NO LED lights on button presses, the batteries should be changed.</p>

APPENDIX A

TV Codes for Remote Pairing - Top 10 US TV Brands -

TV Maker/ Brand	Code Number										
SAMSUNG	10305	10265	10001	10012	10051	10092	10011	10118	10124	10132	10145
	10176	10221	10306	10542	10315	10439	10479	10408	10543		
LG(GOLDSTAR)	20069	20077	20018	10192							
SONY	20008	20176	20005	20025	20107	20145	20090	20170	20195	20209	20216
	20305	20446									
VIZIO	20180										
PANASONIC	20126	20014	20039	20094	20194	20200					
SHARP	20139	20058	20033	20100	20132	20133	20134	20127			
TOSHIBA	20155	20118	20237	20255							
DYNEX	10091	10347	10366								
TCL	10256	10371	10267	10553							
SKYWORTH	10522										

Brand List TV

TV Maker/ Brand	Code Number										
3M	10368										
A MARK	10103	10132	10388								
ACTION	10370										
ADMIRAL	10436	10431									
ADVENT	10135	10339									
ADVENTURA	10372										
AFTRON	10373										
AIKO	10374										
AIWA(R-44A)	10082	10183									
AKAI	10148	10160	10001	10317	10318	10348	10352	10542	10439	10476	10517
ALARON	10376										
ALBATRON	10377										
AMBASSADOR	10378										
AMERICA ACTION	10380										
AMPRO	10070	10164	10249	10381							
AMSTRAD	10053										
ANAM	10045	10055	10057	10076	10095	10099	10103	10109	10112	10143	10380
	10288										
AOC	10088	10363	10367	10001	10011	10103	10330	10439			
AOMNI	10354										
APEX	10302	10303	10282								
APEX DIGITAL	10303	10373	10384								
ARCHER	10388										
ASTAR	10390										
ATYME	10272										
AUDIOVOX	10345	10319	10380	10374	10388						
AURORA SYSTEMS	10391										
AVENTURA	10311										
AVERA	10282										
BANG & OLUFSEN	10554	10555	10557								
BELCOR	10001	10011	10315								
BELL & HOWELL	10393										
BENQ	10395	10396									
BLAUPUNKT	10084										

Brand List TV

TV Maker/ Brand	Code Number										
BLU:SENS	10476	10455	10499								
BOLVA	10282										
BRADFORD	10380										
BRILLIAN	10398										
BROCKWOOD	10011	10315									
BROKSONIC	10143	10166	10174	10431							
BUSH	10399										
BYD:SIGN	10400										
CANDLE	10001	10002	10003	10011	10439	10372	10543				
CANON	10402	10403									
CAPEHART	10059										
CARNIBALE	10001	10439									
CARVER	10415	10405									
CASIO	10406	10407									
CCE	10408										
CELEBRITY	10409										
CELERA	10303										
CETRONIC	10045										
CHANGHONG	10303										
CITIZEN	10001	10002	10003	10011	10045	10092	10094	10132	10439	10374	10372
	10543	10517									
CLARION	10380										
CLASSIC	10045										
COBY	10412	10011	10275								
COMMERCIAL SOLUTIONS	10413										
COMPAQ	10414										
CONCERTO	10011	10543									
CONTEC	10041	10045	10051	10052	10380						
CORENA SYSTEM	10301	10586									
CORONADO	10132										
CRAIG	10045	10055	10157	10049	10159	10380	10258				
CROSLEY	10415										
CROWN	10045	10132	10380								
CURTIS MATHES	10001	10092	10011	10132	10365	10413	10415	10393	10319	10436	10542

Brand List TV

Soundbar Maker/ Brand	Code Number										
AMAZON	20414										
APEX	20425										
AUVIO	20403										
BOHM	20423										
BOSE	20440										
DENON	20428										
EMATIC	20412										
GOODMANS	20438										
HAIER	20433										
HARMAN KARDON	20205										
INSIGNIA	20431										
JAMO	20435										
JBL	20432										
JVC	20430										
KLIPSCH	20421										
LG(GOLDSTAR)	20069										
MAXWELL	20445										
MEGACRA	20402										
MEIDONG	20417										
MIGHTY ROCK	20410										
NAKAMICHI	20443										
ONKYO	20178										
ORB AUDIO	20418										
ORBITSOUND	20413										
PHILIPS	20009										
POLK AUDIO	20439										
PRECISION ACOUSTICS	20424										
PROSCAN	20409										
PYLE	20426										
QUAD	20408										
REFLEXION	20419										
RICH SOUND RESEARCH(RSR)	20405										
SAMSUNG	20304										
SANYO	20429										

Brand List TV

TV Maker/ Brand	Code Number										
EMPREX	10425										
ENVISION	10439	10358	10330								
ENVIXION	10001										
EPSON	10364										
ERAE	10442										
ESA	10317	10318	10311								
FISHER	10013	10058	10393								
FUJITSU	10149	10228	10333	10334	10376						
FUNAI	10033	10045	10380	10311	10376	10452					
FUTURETECH	10045	10380									
GATEWAY	10310	10486									
GE	10001	10014	10015	10038	10057	10070	10083	10011	10121	10133	10141
	10145	10413	10319	10315	10489	10484					
GILBRALTER	10001	10011	10439	10315							
GO VIDEO	10443	10479	10476								
GOODMANS	10445										
GPX	10276										
GRADIENTE	10040										
GRUNDIG	10288	10289	10575	10576	10577						
GRUNPY	10380	10376									
GVA	10278										
H & B	10301										
HAIER	10026	10322	10323	10324	10325	10326	10434	10373	10067	10136	
HALL MARK	10011	10315									
HANNS.G	10447										
HANNSPREE	10448	10449	10447	10263	10264						
HARLEY DAVIDSON	10451	10376	10452								
HARMAN KARDON	10034	10180	10181	10415							
HARVARD	10380	10453									
HAVERMY	10436										
HELIOS	10301										
HELLO KITTY	10319										
HEWLETT PACKARD	10456	10330	10458								
HISENSE	10266	10011	10279	10280	10373	10459	10462	10590			

Brand List TV

TV Maker/ Brand	Code Number										
HITACHI HITACHI	10017	10011	10015	10016	10001	10018	10029	10043	10072	10132	10144
	10147	10203	10204	10206	10207	10208	10210	10211	10368	10452	10543
HP	10357										
HUMAX	10143										
HYPERION	10011										
HYUNDAI	10460	10461									
I-INC	10463										
ILO	10091	10343	10362	10356							
INFINITY	10415	10148									
INFOCUS	10464	10364	10466	10467							
INITIAL	10356										
INKEL	10120										
INSIGNIA	10091	10366	10311	10417	10274						
JBL	10148	10415									
JCPENNY	10001	10011	10014	10015	10030	10035	10092	10132	10145		
JENSEN	10019	10234									
JVC	10261	10270	10038	10040	10079	10239	10550				
KAWASHO	10470										
KDS	10335										
KEC	10045	10380									
KENWOOD	10001	10229	10011	10439	10315						
KLEGG	10354										
KLH	10341	10303									
KLOSS	10002	10060	10001	10372							
KMC	10132										
KNOLL SYSTEMS	10467										
KONKA	10473	10475	10476	10477	10591						
KOST	10478	10479									
KREISEN	10480	10479									
KT	10001	10045	10132	10140	10308						
KTV	10380	10439									
LG(GOLDSTAR)	10011	10093	10103	10113	10118	10132	10346	10315	10439		
LLOYD'S	10452										
LODGENT	10069										

Brand List TV

TV Maker/ Brand	Code Number										
LOEWE	10481										
LOGIK	10069										
LUCE	10358	10483									
LUXMAN	10011	10543									
LXI	10013	10021	10053	10034	10145	10148	10413	10415	10393	10303	10315
MAGNASONIC	10001	10011	10348								
MAGNAVOX	10001	10003	10011	10060	10061	10062	10064	10065	10066	10086	10088
	10118	10132	10145	10148	10192	10212	10236	10244	10312	10332	10415
	10439	10356	10505	10452	10330	10376	10126				
MAGNIN	10484										
MARANTZ	10001	10074	10148	10415	10439						
MATSUI	10148										
MATSUSHITA	10485										
MAXENT	10486	10487									
MB QUART	10315										
MEGATRON	10315	10368	10388	10435							
MEMOREX	10013	10069	10091	10011	10393	10431	10315	10376	10516		
METZ	10084										
MGA	10001	10011	10033	10044	10050	10074	10315	10439	10484		
MIDLAND	10413										
MINERVA	10084										
MINTEK	10356										
MITSUBISHI	10216	10011	10030	10033	10034	10041	10044	10089	10115	10160	10167
	10168	10214	10001	10245	10436	10315					
MONIVISION	10377										
MONTGOMERY WARD	10185	10217	10218	10219	10220						
MOTOROLA	10436	10335									
MOXELL	10335										
MTC	10001	10011	10439	10315	10543						
MULTITECH	10380										
NAD	10021	10031	10303	10315	10543						
NAKAMICHI	10491										
NAXA	10492										
NEC	10001	10013	10022	10025	10030	10041	10057	10121	10125	10011	10235

Brand List TV

TV Maker/ Brand	Code Number										
NEC	10439	10315	10543	10405	10344						
NETTV	10486										
NIKEI	10045										
NIKKO	10001	10315	10439	10374							
NIKO	10493										
NOBLEX	10494										
NORCENT	10373	10330	10495	10493							
NORWOOD MICRO	10362	10498									
NTC	10374										
NUVISION	10502										
OLEVIA	10011	10342	10535	10315							
OLYMPUS	10503										
ONWA	10045	10380									
OPTONICA	10025	10034	10235								
OPTIMUS	10485	10393	10504	10505							
OPTOMA	10506	10448									
OPTONICA	10436										
ORION	10431	10376	10516								
PANASONIC	10076	10010	10038	10057	10005	10148	10150	10169	10308	10359	10485
PENNEY	10001	10011	10413	10303	10315	10439	10484	10489	10388	10592	
PHILCO	10001	10003	10011	10030	10045	10057	10060	10061	10064	10065	10118
	10132	10148	10415	10439	10315						
PHILIPS	10148	10321	10011	10040	10060	10067	10132	10145	10001	10222	10003
	10371	10415	10479	10556							
PILOT	10001	10011	10439	10315							
PIONEER	10504	10024	10029	10031	10032	10011	10248	10254	10304	10001	
POLAROID	10335	10338	10339	10340	10341	10303	10417	10362	10478	10301	10476
	10593										
PORTLAND	10011	10132	10374	10315	10335	10424	10476				
PROSCAN	10133	10249	10413	10262	10257	10268	10067	10269	10288		
PROTON	10059	10011	10103	10132	10165	10251	10315	10388			
PROTRON	10507	10508									
PROVIEW	10335										
PULSAR	10011	10315									

Brand List TV

TV Maker/ Brand	Code Number										
PUNEET	10425										
PVISION	10442										
QUASAR	10038	10057	10243	10308	10485						
RADIO SHACK	10025	10045	10048	10011	10118	10132	10001	10235			
RCA	10001	10004	10006	10011	10029	10030	10057	10083	10133	10145	10161
	10171	10232	10371	10413	10484	10315	10256	10272	10553	10556	
REALISTIC	10013	10025	10045	10048	10001	10011	10235	10393	10380	10315	10439
	10543										
REVOLUTIONHD	10354										
ROCTEC	10237										
RUNCO	10152	10153	10001	10250	10252	10336	10337	10439			
SAMPO	10001	10059	10011	10486	10439						
SAMSUNG	10305	10265	10001	10012	10051	10092	10011	10118	10124	10132	10145
	10176	10221	10306	10542	10315	10439	10479	10408	10543		
SANSUI	10431	10452	10516	10517							
SANYO	10013	10026	10027	10037	10041	10054	10058	10078	10253	10393	10402
	10484										
SCEPTRE	10313	10067	10565	10136							
SCIMITSU	10011	10315									
SCOTT	10033	10045	10049	10011	10132	10380	10315	10376			
SCOTCH	10315										
SEARS	10011	10013	10021	10033	10035	10058	10078	10092	10132	10145	10244
	10413	10415	10393	10303	10315	10311	10543	10376	10452		
SEIKI	10259	10283	10284	10285	10286	10287					
SELECO	10368	10430									
SHARP	10260	10020	10025	10028	10033	10034	10132	10151	10235	10236	10361
	10375	10436	10011	10560							
SHARPER IMAGE	10518										
SHERWOOD	10120										
SHOGUN	10011	10315									
SIEMENS	10084										
SIGCUS	10594										
SIGNATURE	10069	10011									
SIGNATURE 2000	10011										

Brand List TV

TV Maker/ Brand	Code Number										
SIGNET	10519	10478	10520								
SIM2 MULTIMEDIA	10430										
SIMPSON	10001										
SKYWORTH	10522										
SODIFF	10595										
SOLARISM	10523										
SOLE	10358	10483	10301	10479	10354						
SONY	10043	10075	10117	10130	10067	10170	10238	10247	10309	10409	10452
	10136										
SOUNDESIGN	10003	10033	10045	10011	10380	10315	10376				
SOVA	10507										
SOYO	10425	10463	10524	10525	10476						
SPECTRICON	10103	10011	10388								
SPECTRONIQ	10335										
SQUAREVIEW	10311										
SSS	10011	10045	10380	10315							
STARLITE	10011	10380									
STUDIO EXPERIENCE	10377										
SUNBRITE	10528	10529	10136								
SUPERSCAN	10436	10530									
SUPERSONIC	10596										
SUPRE MACY	10002	10372									
SUPREME	10409										
SVA	10373	10479	10301	10532	10533						
SYLVANIA	10001	10003	10008	10011	10060	10061	10064	10118	10126	10065	10145
	10148	10155	10311	10355	10415	10439					
SYMPHONIC	10380	10311	10452	10505							
SYNTAX	10342	10535	10315								
TANDY	10034	10436									
TASHIKO	10537										
TATUNG	10057	10063	10388	10458	10362						
TCL	10256	10371	10267	10553							
TEAC	10379	10281	10564								
TECHNICS	10080	10076	10485								

Brand List TV

TV Maker/ Brand	Code Number										
TECHNOL ACE	10376										
TECHVIEW	10539	10541									
TECHWOOD	10011	10388	10543								
TELEMAGIC	10402										
TEKNIKA	10001	10002	10003	10011	10030	10033	10036	10045	10069	10074	10092
	10094	10132	10415	10380	10374	10315	10543	10376			
TELEFUNKEN	10039	10047	10241	10242	10542	10543	10544				
TELERENT	10069										
TERA	10156										
THOMAS	10452										
TMK	10011	10315	10543	10378							
TOSHIBA	10021	10013	10035	10041	10052	10063	10092	10142	10146	10178	10179
	10393	10303	10464	10419	10517						
TOTEVISION	10132										
TRUTECH	10353										
TVS	10431										
ULTRA	10547	10508									
UNIVERSAL	10014	10015									
UPSTAR	10277	10597									
US LOGIC	10362										
VECTOR RESEARCH	10001	10439									
VENTURER	10315										
VICTOR	10550										
VIDEO CONCEPTS	10160										
VIDIKRON	10255	10415									
VIDTECH	10011	10315									
VIEWSONIC	10363	10088	10330	10331	10349	10486	10530	10503			
VIKING	10372										
VIORE	10316										
VISART	10551										
VITO	10360										
VIZIO	10011	10315	10351	10530							
WARDS	10011	10014	10015	10025	10033	10061	10062	10064	10065	10069	10071
	10132	10148	10001	10235	10415	10315	10439	10489	10543	10376	

Brand List TV

TV Maker/ Brand	Code Number										
WAYCON	10303										
WHITEWESTINGHOUSE	10091	10319	10320	10327	10328	10329	10067	10431	10409	10136	
WINBOOK	10362										
WOORYOUNG	10307										
WYSE	10330										
XIAOMI	10588										
XOCECO	10552										
YAMAHA	10001	10011	10439	10315							
YORK	10011										
ZENITH	10009	10069	10070	10090	10094	10431	10315	10374	10452	10516	
ZONDA	10103	10388									

APPENDIX B

Audio System Codes for Remote Pairing Brand List AUDIO

Audio Maker/Brand	Code Number										
ADCOM	20088	20098	20218	20147	20233						
AIWA	20142	20182	20025	20141	20022	20110					
AKAI	20128										
AMAZON	20414										
ANAM	20026	20188	20189								
ANTHEM	20004										
APEX	20425										
AUVIO	20403										
B&K	20102	20103									
BOHM	20423										
BOSE	20007	20185	20131	20440							
CARVER	20253	20013	20037	20060	20068	20148	20221	20226	20245	20250	20015
CLARION	20132										
COBY	20010	20017									
DENON	20041	20234	20111	20149	20150	20152	20232	20003	20428		
EMATIC	20412										
ENLIGHTENED	20105										
EVERQUEST	20032										
FISHER	20037	20015	20083	20207							
FOSGATE AUDIONIC	20153										
GOODMANS	20438										
HAIER	20019	20023	20433								
HARMAN KARDON	20205	20208	20153	20228	20229	20249					
HITACHI	20035	20040	20027	20202							
ILIVE	20049	20050	20311								
INKEL	20012										
INSIGNIA	20061										
JAMO	20435										
JBL	20432										
JCPENNY	20016	20108									
JENSEN	20065										
JVC	20112	20430									

Brand List AUDIO

Audio Maker/Brand	Code Number										
KENWOOD	20012	20206	20231	20033	20015	20211	20212	20213	20214	20215	20222
	20230	20134	20246								
KLIPSCH	20421	20437									
LEXICON	20125	20156	20158	20159							
LG(GOLDSTAR)	20069	20077	20018	20192							
LOTTE	20191	20193									
LUXMAM	20042										
LXI	20084										
MAGNAVOX	20013	20092									
MARANTZ	20013	20093	20047	20072	20063	20203	20221	20250			
MAXELL	20078										
MAXWELL	20445										
MCINTOSH	20160										
MCS	20016										
MEGACRA	20402	20319									
MEIDONG	20417										
MIGHTY ROCK	20410										
mitsubishi	20164	20165									
NAD	20036										
NAKAMICHI	20167	20047	20443	20450	20320						
NILES	20168										
ONKYO	20178	20053	20113	20114	20024	20177	20179	20223	20224	20251	
OPTIMUS	20029	20033	20048								
ORB AUDIO	20418										
ORBITSOUND	20413										
OUTLAW	20183										
PANASONIC	20126	20014	20039	20094	20194	20200					
PARASOUND	20254										
PHILIPS	20009	20301	20302	20303	20093	20013	20172	20124			
PIONEER	20082	20021	20046	20051	20057	20073	20076	20096	20001	20054	20237
	20238	20239	20240	20241	20242	20243	20244				
POLK AUDIO	20439										
PRECISION ACOUSTICS	20424										
PROCEED	20006	20248	20252								

Brand List AUDIO

Audio Maker/Brand	Code Number										
PROSCAN	20409										
PYLE	20426	20447	20448								
QUAD	20408										
QUASAR	20014	20094									
RCA	20062	20106	20120	20138	20056	20123					
REALISTIC	20011	20030	20084	20002	20026	20101					
REFLEXION	20419										
RICH SOUND RESEARCH(RSR)	20405										
ROTEL	20089	20080	20091								
SAMSUNG	20304	20197	20198	20199	20306						
SANSUI	20116	20013	20124	20047							
SANYO	20187	20429									
SCOTT	20026	20097									
SENTRY	20407										
SHARP	20139	20058	20033	20100	20132	20133	20134	20127			
SHERWOOD	20045	20031	20247								
SONOS	20449										
SONY	20008	20176	20005	20025	20107	20145	20090	20170	20195	20209	20216
	20305	20446									
SOUNDESIGN	20043										
SSI	20075										
TAEKWANG	20128	20186	20195								
TAOTRONICS	20416										
TEAC	20066	20067	20026	20190							
TECHNICS	20126	20094	20109	20014	20137						
THOMSON	20217										
TOSHIBA	20155	20118	20237	20255							
VELOCITYNE	20404										
VICTOR	20020	20112									
VIZIO	20180										
VOGELS	20411										
WARDS	20015										
YAMAHA	20140	20166	20201	20028	20033	20038	20074	20132	20175	20204	20210
	20219	20220	20227	20235	20236	20427					

Brand List AUDIO

Audio Maker/Brand	Code Number											
ZANTEK	20174											
ZVOX	20401											

Brand List SOUNDBAR

Soundbar Maker/ Brand	Code Number										
AMAZON	20414										
APEX	20425										
AUVIO	20403										
BOHM	20423										
BOSE	20440										
DENON	20428										
EMATIC	20412										
GOODMANS	20438										
HAIER	20433										
HARMAN KARDON	20205										
INSIGNIA	20431										
JAMO	20435										
JBL	20432										
JVC	20430										
KLIPSCH	20421										
LG(GOLDSTAR)	20069										
MAXWELL	20445										
MEGACRA	20402										
MEIDONG	20417										
MIGHTY ROCK	20410										
NAKAMICHI	20443										
ONKYO	20178										
ORB AUDIO	20418										
ORBITSOUND	20413										
PHILIPS	20009										
POLK AUDIO	20439										
PRECISION ACOUSTICS	20424										
PROSCAN	20409										
PYLE	20426										
QUAD	20408										
REFLEXION	20419										
RICH SOUND RESEARCH(RSR)	20405										
SAMSUNG	20304										
SANYO	20429										

Brand List SOUNDBAR

Soundbar Maker/ Brand	Code Number										
SENTRY	20407										
SONOS	20449										
SONY	20446										
TAOTRONICS	20416										
TOSHIBA	20422										
VELODYNE	20404										
VIZIO	20451										
VOGELS	20411										
YAMAHA	20427										
ZVOX	20401										

Notes



Contact NITCO help desk at 219-996-7000 for additional help.